

# LINSY 林氏家居

## 安装示意图/Assembly Instruction

产品名称 Model NO.	BY037-A/BY037-B
产品规格 Specification	590*645*920-1015
安装工具 Tool	安装人数 Installer

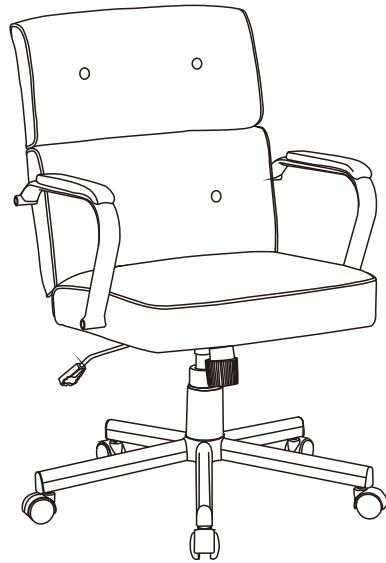
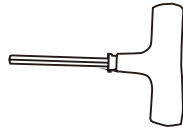

## 五金表/Hardware list

<p>(A)*5 椅轮 Castor</p>	<p>(B)*5 五爪 Foot Tube</p>	<p>(C)*1 中心座 Center seat</p>
<p>(D)*1 气压棒 Pneumatic rod</p>	<p>(E)*5 大扁头六角耐落螺丝6*20 Large flat head hexagon drop proof screw6*20</p>	<p>(F)*6 内外六角耐落螺丝8*25 Inner and outer hexagon drop screws8*25</p>
<p>(G)*2 内外六角耐落螺丝8*30 Inner and outer hexagon drop screws8*30</p>	<p>(H)*4 平头内六角耐落螺丝8*45 Flat head hexagon socket head drop resistant screw8*45</p>	<p>(I)*1 扳手 Wrench</p>
<p>(J)*4 闷盖 Capping</p>		

## 部件表/Parts List

编号NO.	名称Name	规格 Specification	数量QTY	材质Material
①	靠背 Backrest		1	海绵+PU+多层板 Sponge+PU+Multilayer board
②	座垫 Cushion		1	海绵+PU+多层板 Sponge+PU+Multilayer board
③	左扶手 Armrest (L)		1	铁 Iron
④	右扶手 Armrest (R)		1	铁 Iron
⑤	底盘 Tray		1	铁 Iron

BY037-A/BY037-B

安装方法/ Installation method

### STEP 1

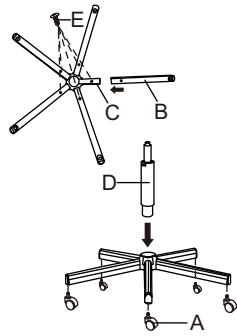

如图将五爪B插入中心座C，使用椅脚螺丝E固定然后把脚轮A分别装入椅脚的五个脚孔，再将气压棒D装入椅脚的中心孔  
Insert the foot tube B into the center seat C as shown in the figure, fix it with the chair foot screw E, then install the caster A into the five foot holes of the chair foot, and then install the air pressure rod D into the center hole of the chair foot

### STEP 2

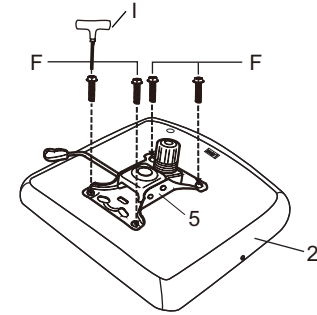

如图安装底盘，依次锁上四颗底盘螺丝F，螺丝全部锁入后用扳手加固锁紧  
Install the chassis as shown in the figure, and lock four chassis screws F in turn. After all the screws are locked in, tighten them with a wrench

### STEP 3

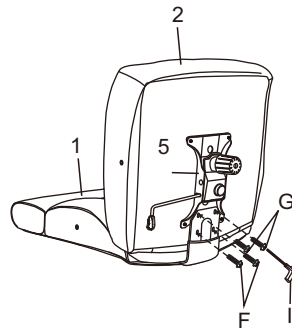

如图将靠背和坐垫连接，上端锁入螺丝G，下端锁入螺丝F，螺丝全部锁入后用扳手加固锁紧  
Connect the backrest with the cushion as shown in the figure. Lock the screw G at the upper end and the screw F at the lower end. After all the screws are locked, tighten them with a wrench

### STEP 4

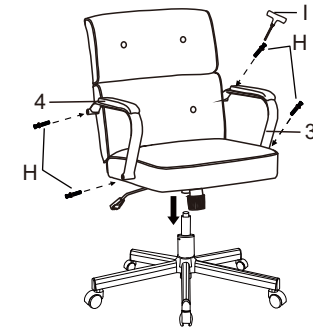

如图将左扶手右扶手锁入两颗螺丝H，螺丝全部锁入后用扳手加固锁紧  
As shown in the figure, lock the left armrest and the right armrest with two screws H. After all the screws are locked, tighten them with a wrench

### STEP 5

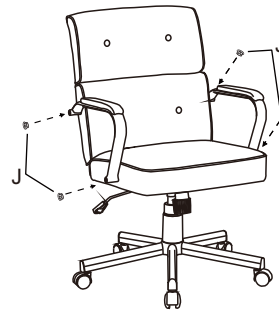

如图将左扶手及右扶手锁入的螺丝上，依次盖上闷盖J固定  
As shown in the figure, lock the left armrest and the right armrest onto the screws, and cover the J for fixation

### STEP 6

