

### 安装示意图/Assembly Instruction

产品名称 Model NO.	CC1L-A 1.2M
产品规格 Specification	1200*580*353mm
安装工具 Tool	安装人数 Installer
	

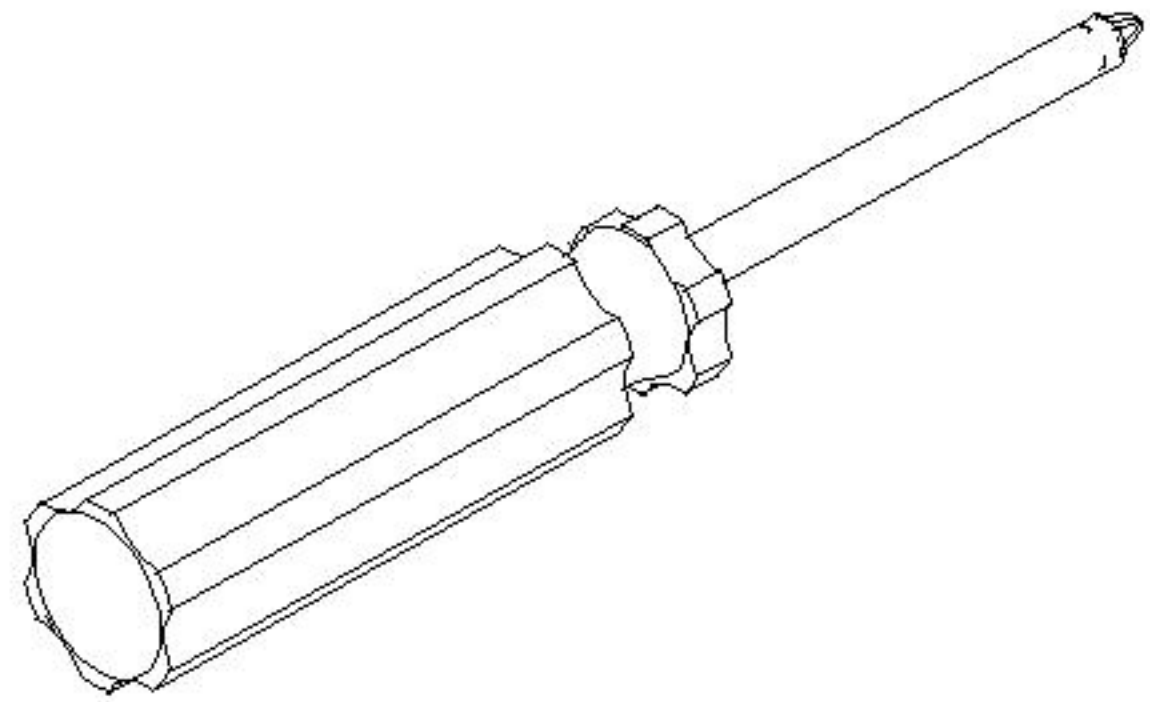
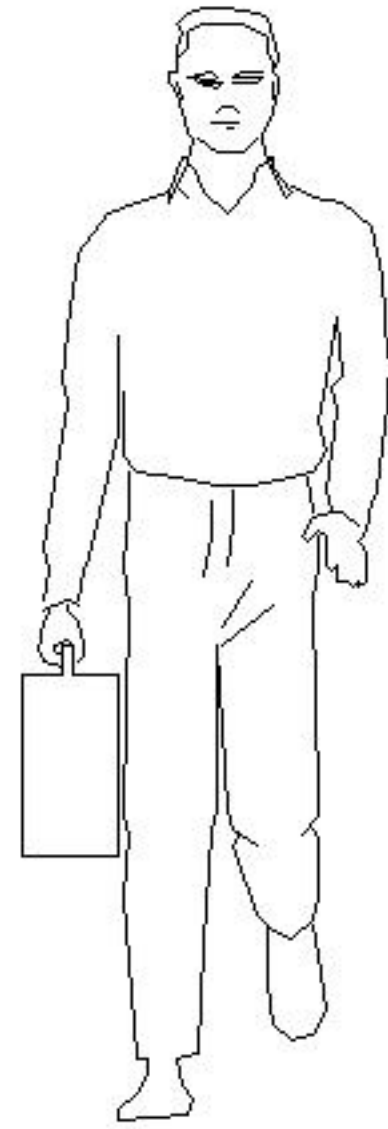
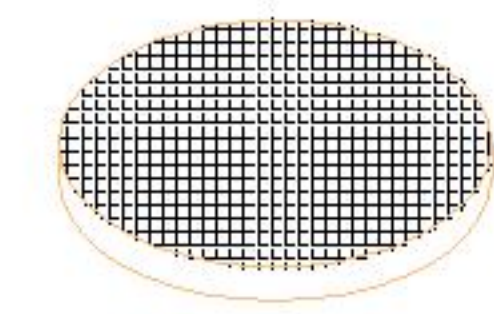
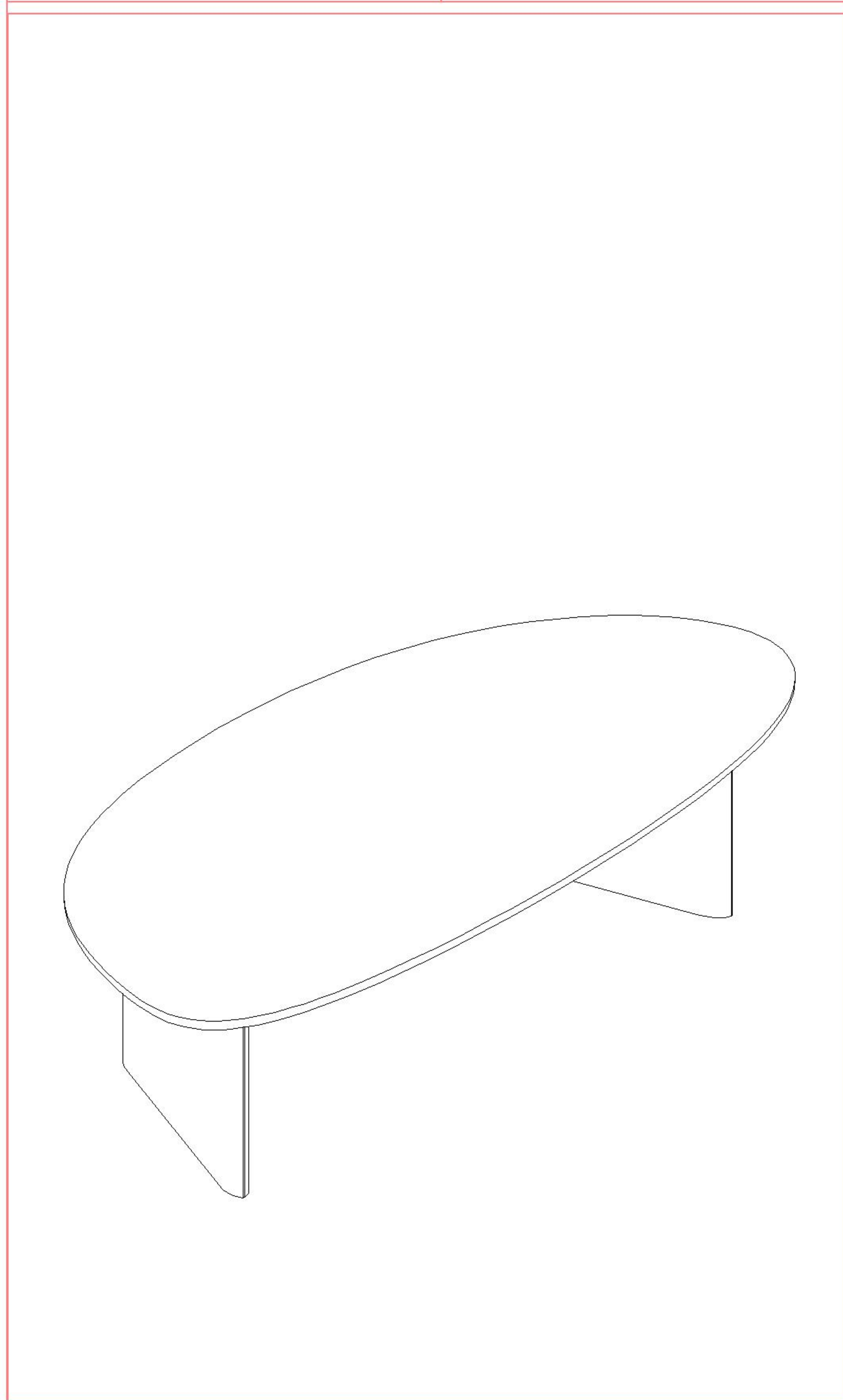

(A)\* 4

灰色毛毡垫  
Foot pad

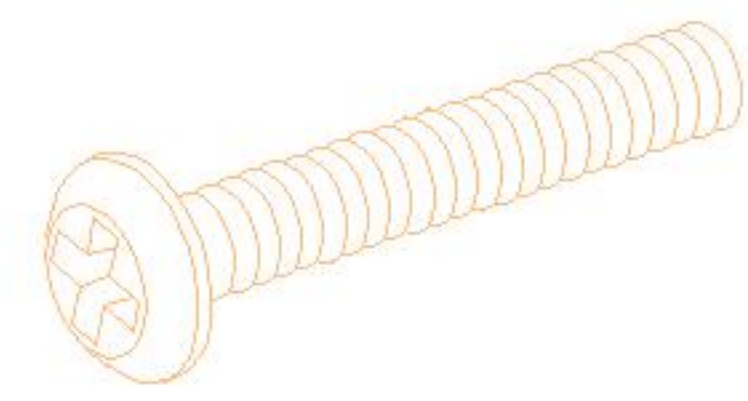

(B)\* 8

斜边十字螺杆-M6\*30  
bevel cross screw

编号NO.	名称 Name	规格 (mm) Specification	数量QTY	材质 Material
①	面板Top panel	1200*580*24	1	实木Wood
②	脚1 Foot 1	395*95*326	2	实木Wood



CC1L-A 1.2M

安装方法/Installation  
method



(A)\*4

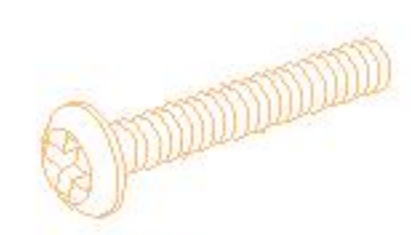

(B)\*8

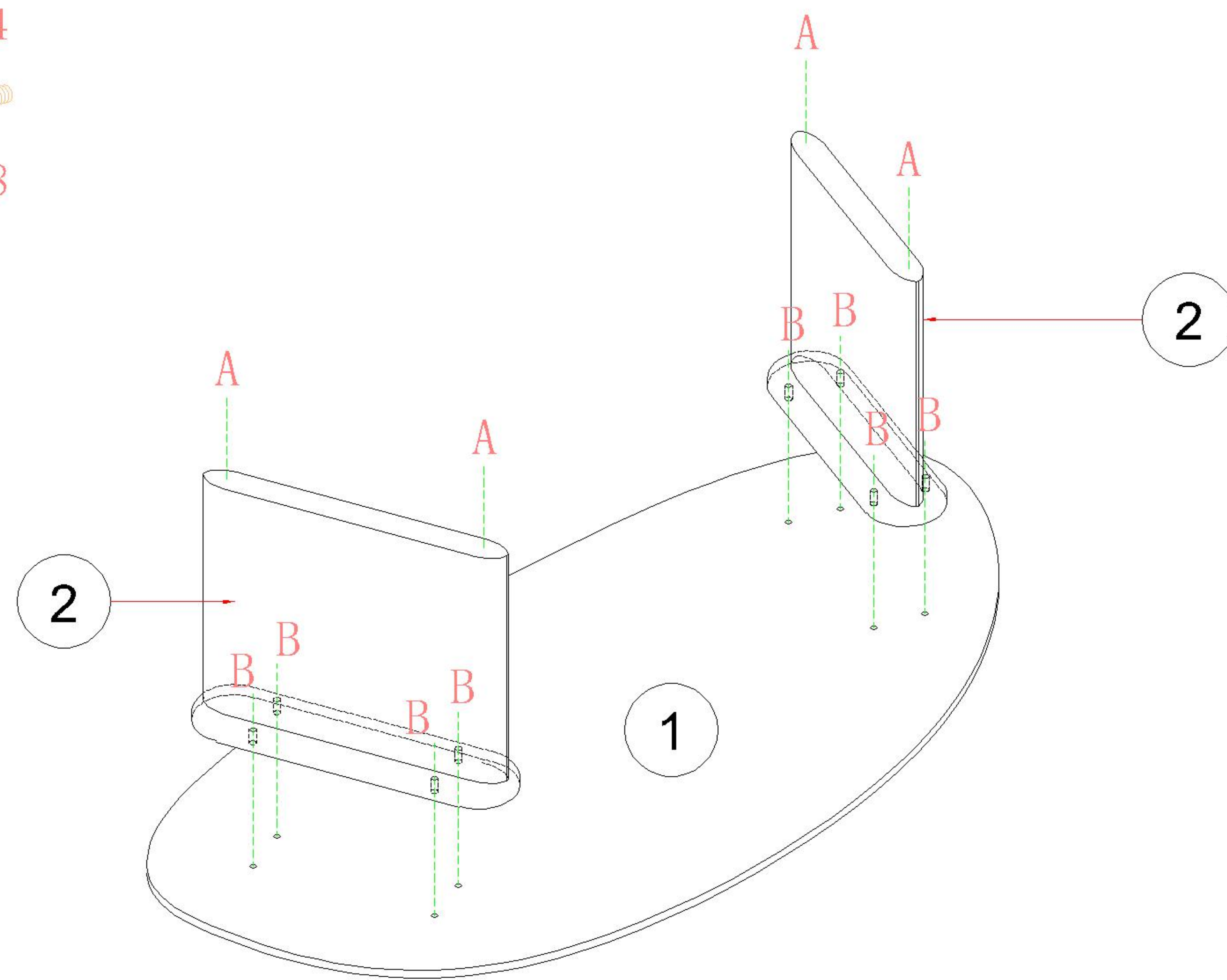

1

2

